

ET855

AMD Athlon™ II / Turion™ II Neo CPU
785E + SB820M
COM Express (Type II) CPU Module

USER'S MANUAL

Version 1.0

Acknowledgments

PS/2 is a trademark of International Business Machines Corporation.

AMD and Athlon™ II Neo are registered trademarks of Advanced Micro Devices, Inc.

Microsoft Windows is a registered trademark of Microsoft Corporation.

All other product names or trademarks are properties of their respective owners.

Table of Contents

Introduction	1
Product Description	1
Checklist	2
ET855 Specifications.....	3
Dimensions	4
Installing the Memory	5
Jumpers and Connectors on ET855.....	6
JB1: Clear CMOS Setting	6
J2, J3: COM Express Type 2 Connectors	6
COM Express Type 2 Connectors	7
BIOS Setup.....	9
Drivers Installation	29
VGA Drivers Installation	30
Audio Drivers Installation	35
LAN Drivers Installation	36
Marvell LAN Drivers Installation (IP401-B1 carrier board only).....	38



The ET855 COM Express CPU Module

Introduction

Product Description

The ET855 COM Express Module comes on board with the AMD Athlon II Neo or AMD Turion II Neo processors and powered by the AMD 785E + SB820M chipset. The chipset has built-in Radeon HD4200 graphics engine with enhanced operating modes to enable excellent graphics performance in power and embedded applications. The

DirectX® 10.1 feature lets you enjoy awesome graphics performance, stunning 3D visual effects and dynamic Interactivity.

The board has two DDR3-800/1333 SO-DIMM sockets supporting up to 8GB of system memory. ET855 supports high speed connectivity with two SATA III, four serial ports, eight USB and a Gigabit LAN controller. Dimensions of the CPU module are 95mm x 125mm.

ET855 Features

- AMD Athlon™ II Neo / Turion™ II Neo Processors on board, up to 2.2GHz
- 2x DDR3-800/1333 SO-DIMM, Max. 8GB
- Integrated VGA, supports CRT & LVDS
- Watchdog timer, HD Audio
- 2x SATA II, 1x GbE, 8x USB 2.0, 4x COM via baseboard

Checklist

Your ET855 package should include the items listed below.

- The ET855 CPU Module
- Heat spreader for ET855
- This User's Manual
- 1 CD containing the following:
 - Chipset Drivers
 - Flash Memory Utility

Remarks: After installing the heat spreader (provided with the CPU module), please install an additional heat spreader for better heat dissipation.

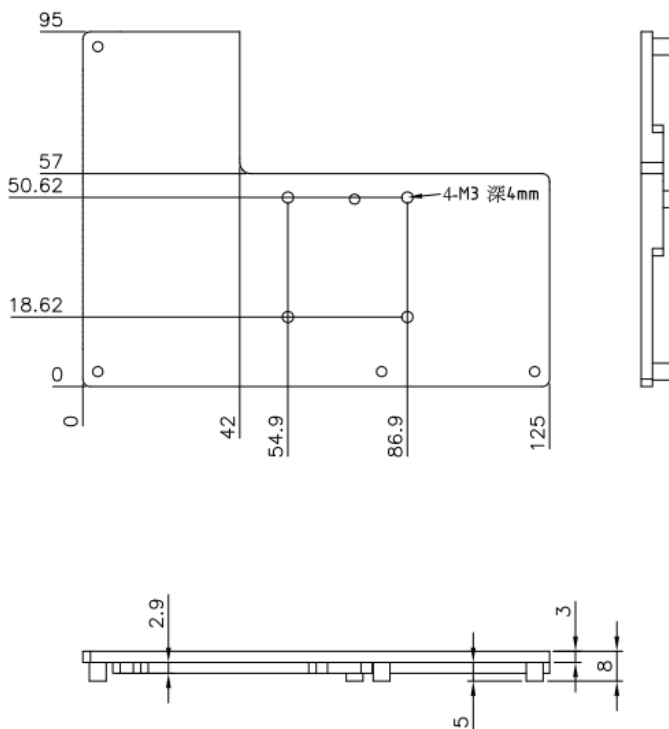

ET855 Specifications

Product Name	ET855
Form Factor	COM Express CPU module
CPU Type	AMD Geneva ASB2 Turion™ II Neo / Athlon™ II Neo DC CPU
CPU Operate Frequency	Dual-Core CPU (27 x 27 mm) /45nm SOI / ECC capable FSB up to 3200 MHz Hyper Transport AMD Athlon™ II Neo N36L=1.3GHz DC (12W) AMD Turion™ II Neo N54H=2.2GHz DC (25W) [Default]
Cache	2MB
CPU Socket	812-ball BGA ASB2 CPU on board
Chipset	AMD 785E NB : 21 mm x 21 mm AMD SB820M SB: 21mm x 21mm
BIOS	AMI BIOS
Memory	DDR3 SO-DIMM x 2 , Max. 8GB (Non-ECC) , dual-channel DDR3-800 for N36L ; DDR3-1333 for N54H
VGA	AMD 785E built-in ATi HD4200 Graphics Core CRT thru interface on carrier board
LVDS	AMD 785E built-in 1 x 24-bit dual channels Thru interface on carrier board
LAN	Realtek 8111DL PCI-Express GbE x 1
USB	SB820M built-in USB 2.0 host controller, supports 8 ports
Serial ATA Ports	SB820M built-in controller, supports 2 ports for SATA 3.0 (6 Gb/s)
Parallel IDE	JMicron JM368 (PCI-e to PATA) x1 for 1 PATA channel for IDE
Audio	SB820M Built-in Audio controller with external HD codec on carrier board
RTC	SB820M built-in RTC, battery on carrier board
Watch-Dog Timer	Yes (256 segments, 0, 1, 2...255. sec/min)
Connector to Carrier Board	Two 220-pin connectors (A-B & C-D) [COM Express 2.0 standard]
Power	+12V ,+5VSB
Other	LAN Wakeup , Heat spreader as standard, optional heatsink
RoHS	Yes
Board Size	95mm x 125mm

Dimensions

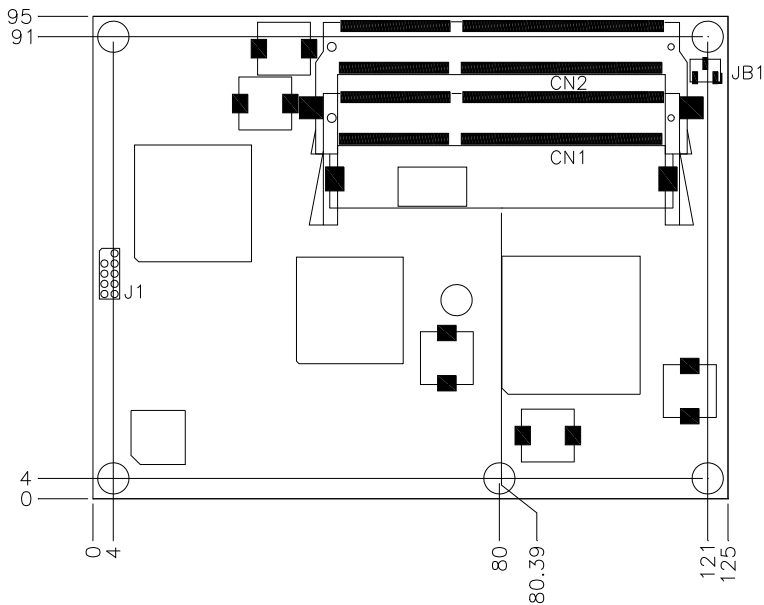

Remarks: After installing the heat spreader (provided with the CPU module), please install an additional heat spreader for better heat dissipation.

Installing the Memory

The ET855 COM Express CPU module accommodates 240-pin DDR3 SODIMM memory modules with capacities up to 8GB. Non-ECC is supported.

Installing and Removing Memory Modules

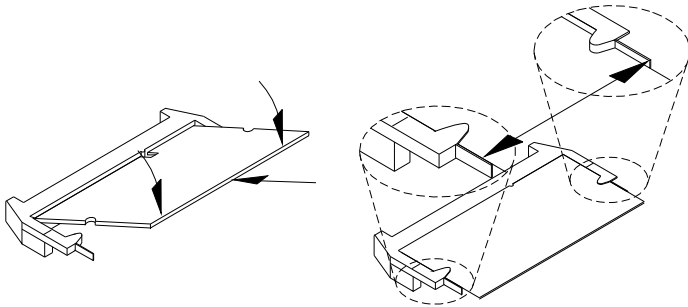

To install the DDR3 modules, locate the memory slot on the board and perform the following steps:

1. Hold the DDR3 module so that the key of the DDR3 module align with those on the memory slot. Insert the module into the socket at a slight angle (approximately 30 degrees). Note that the socket and module are both keyed, which means that the module can be installed only in one direction.
2. To seat the memory module into the socket, apply firm and even pressure to each end of the module until you feel it slip down into the socket.
3. With the module properly seated in the socket, rotate the module downward. Continue pressing downward until the clips at each end lock into position.
4. To remove the DDR3 module, press the clips with both hands.



Jumpers and Connectors on ET855

JB1: Clear CMOS Setting

JB1	Setting
	Normal
	Clear CMOS

Note: With jumper pin 1-2 short, it automatically saves the last BIOS settings when battery is removed, but it is not case with jumper pin 2-3 short.

J2, J3: COM Express Type 2 Connectors

The Type 2 connectors come in two 220-pin 0.5mm pitch receptacles. They include PCI, IDE, GBE and up to 22 general-purpose PCIE lanes (PCIE 0-5 and PCIE 16-31). For most Type 2 implementations, it is expected that PCIE lanes 16-31 are used for graphics. Hence they are designated PEG lanes 0-15 in the following table. Modules implementing Pin out Type 2, such as the ET855, uses the pin-out shown.

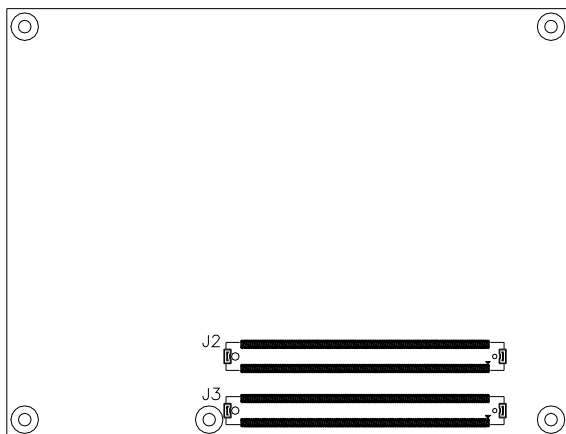

COM Express Type 2 Connectors

Row A		Row B		Row C		Row D	
Pin	Signal	Pin	Signal	Pin	Signal	Pin	Signal
A1	GND (FIXED)	B1	GND (FIXED)	C1	GND (FIXED)	D1	GND (FIXED)
A2	GBE0_MDI3-	B2	GBE0_ACT#	C2	IDE_D7	D2	IDE_D5
A3	GBE0_MDI3+	B3	LPC_FRAME#	C3	IDE_D6	D3	IDE_D10
A4	GBE0_LINK1000#	B4	LPC_AD0	C4	IDE_D3	D4	IDE_D11
A5	GBE0_LINK1000#	B5	LPC_AD1	C5	IDE_D15	D5	IDE_D12
A6	GBE0_MDI2-	B6	LPC_AD2	C6	IDE_D8	D6	IDE_D4
A7	GBE0_MDI2+	B7	LPC_AD3	C7	IDE_D9	D7	IDE_D0
A8	GBE0_LINK#	B8	LPC_DRQ0#	C8	IDE_D2	D8	IDE_REQ
A9	GBE0_MDI1-	B9	LPC_DRQ1#	C9	IDE_D13	D9	IDE_IOW#
A10	GBE0_MDI1+	B10	LPC_CLK	C10	IDE_D1	D10	IDE_ACK#
A11	GND (FIXED)	B11	GND (FIXED)	C11	GND (FIXED)	D11	GND (FIXED)
A12	GBE0_MDI0-	B12	PWRBTN#	C12	IDE_D14	D12	IDE_IRQ
A13	GBE0_MDI0+	B13	SMB_CLK	C13	IDE_IORDY	D13	IDE_A0
A14	GBE0_CTREF	B14	SMB_DAT	C14	IDE_IOR#	D14	IDE_A1
A15	SUS_S3#	B15	SMB_ALERT#	C15	PCI_PME#	D15	IDE_A2
A16	SATA0_TX+	B16	SATA1_TX+	C16	PCI_GNT2#	D16	IDE_CS1#
A17	SATA0_TX-	B17	SATA1_TX-	C17	PCI_REQ2#	D17	IDE_CS3#
A18	NC	B18	SUS_STAT#	C18	PCI_GNT1#	D18	IDE_RESET#
A19	SATA0_RX+	B19	SATA1_RX+	C19	PCI_REQ1#	D19	PCI_GNT3#
A20	SATA0_RX-	B20	SATA1_RX-	C20	PCI_GNT0#	D20	PCI_REQ3#
A21	GND (FIXED)	B21	GND (FIXED)	C21	GND (FIXED)	D21	GND (FIXED)
A22	NC	B22	NC	C22	PCI_REQ0#	D22	PCI_AD1
A23	NC	B23	NC	C23	PCI_RESET#	D23	PCI_AD3
A24	SUS_S5#	B24	PWR_OK	C24	PCI_AD0	D24	PCI_AD5
A25	NC	B25	NC	C25	PCI_AD2	D25	PCI_AD7
A26	NC	B26	NC	C26	PCI_AD4	D26	PCI_C/BE0#
A27	BATLOW#	B27	WDT	C27	PCI_AD6	D27	PCI_AD9
A28	SATA_ACT#	B28	HDA_SDIN2	C28	PCI_AD8	D28	PCI_AD11
A29	HDA_SYNC	B29	HDA_SDIN1	C29	PCI_AD10	D29	PCI_AD13
A30	HDA_RST#	B30	HDA_SDIN0	C30	PCI_AD12	D30	PCI_AD15
A31	GND (FIXED)	B31	GND (FIXED)	C31	GND (FIXED)	D31	GND (FIXED)
A32	HDA_BITCLK	B32	SPKR	C32	PCI_AD13	D32	PCI_PAR
A33	HDA_SDOUT	B33	I2C_CLK	C33	PCI_C/BE1#	D33	PCI_SERR#
A34	BIOS_DIS0#	B34	I2C_DAT	C34	PCI_PERR#	D34	PCI_STOP#
A35	THRMTTRIP#	B35	THR#	C35	PCI_LOCK#	D35	PCI_TRDY#
A36	USB6-	B36	USB7-	C36	PCI_DEVSEL#	D36	PCI_FRAME#
A37	USB6+	B37	USB7+	C37	PCI_IRDY#	D37	PCI_AD16
A38	USB_6_7_OC#	B38	USB_4_5_OC#	C38	PCI_C/BE2#	D38	PCI_AD18
A39	USB4-	B39	USB5-	C39	PCI_AD17	D39	PCI_AD20
A40	USB4+	B40	USB5+	C40	PCI_AD19	D40	PCI_AD22
A41	GND (FIXED)	B41	GND (FIXED)	C41	GND (FIXED)	D41	GND (FIXED)
A42	USB2-	B42	USB3-	C42	PCI_AD21	D42	PCI_AD24
A43	USB2+	B43	USB3+	C43	PCI_AD23	D43	PCI_AD26
A44	USB_2_3_OC#	B44	USB_0_1_OC#	C44	PCI_C/BE3#	D44	PCI_AD28
A45	USB0-	B45	USB1-	C45	PCI_AD25	D45	PCI_AD30
A46	USB0+	B46	USB1+	C46	PCI_AD27	D46	PCI_IRQC#
A47	VCC_RTC	B47	EXCD1_PERTST#	C47	PCI_AD29	D47	PCI_IRQD#
A48	EXCD0_PERTST#	B48	EXCD1_CPPE#	C48	PCI_AD31	D48	PCI_CLKRUN#
A49	EXCD0CPPE#	B49	SYS_RESET#	C49	PCI_IRQA#	D49	NC
A50	LPC_SERIRQ	B50	CB_RESET#	C50	PCI_IRQB3	D50	PCI_CLK

Row A		Row B		Row C		Row D	
Pin	Signal	Pin	Signal	Pin	Signal	Pin	Signal
A51	GND (FIXED)	B51	GND (FIXED)	C51	GND (FIXED)	D51	GND (FIXED)
A52	PCIE TX5+	B52	PCIE RX5+	C52	PEG RX0+	D52	PEG TX0+
A53	PCIE TX5-	B53	PCIE RX5-	C53	PEG RX0-	D53	PEG TX0-
A54	GPI0	B54	GPO1	C54	NC	D54	PEG LANE RV#
A55	PCIE TX4+	B55	PCIE RX4+	C55	PEG RX1+	D55	PEG TX1+
A56	PCIE TX4-	B56	PCIE RX4-	C56	PEG RX1-	D56	PEG TX1-
A57	GND	B57	GPO2	C57	NC	D57	NC
A58	PCIE TX3+	B58	PCIE RX3+	C58	PEG RX2+	D58	PEG TX2+
A59	PCIE TX3-	B59	PCIE RX3-	C59	PEG RX2-	D59	PEG TX2-
A60	GND (FIXED)	B60	GND (FIXED)	C60	GND (FIXED)	D60	GND (FIXED)
A61	PCIE TX2+	B61	PCIE RX2+	C61	PEG RX3+	D61	PEG TX3+
A62	PCIE TX2-	B62	PCIE RX2-	C62	PEG RX3-	D62	PEG TX3-
A63	GPI1	B63	GPO3	C63	RSVD	D63	RSVD
A64	PCIE TX1+	B64	PCIE RX1+	C64	RSVD	D64	RSVD
A65	PCIE TX1-	B65	PCIE RX1-	C65	PEG RX4+	D65	PEG TX4+
A66	GND	B66	WAKE0#	C66	PEG RX4-	D66	PEG TX4-
A67	GPI2	B67	WAKE1#	C67	RSVD	D67	GND
A68	PCIE TX0+	B68	PCIE RX0+	C68	PEG RX5+	D68	PEG TX5+
A69	PCIE TX0-	B69	PCIE RX0-	C69	PEG RX5-	D69	PEG TX5-
A70	GND (FIXED)	B70	GND (FIXED)	C70	GND (FIXED)	D70	GND (FIXED)
A71	LVDS A0+	B71	LVDS B0+	C71	PEG RX6+	D71	PEG TX9+
A72	LVDS A0-	B72	LVDS B0-	C72	PEG RX6-	D72	PEG TX9-
A73	LVDS A1+	B73	LVDS B1+	C73	SDVO DATA	D73	SDVO_CLK
A74	LVDS A1-	B74	LVDS B1-	C74	PEG RX7+	D74	PEG TX7+
A75	LVDS A2+	B75	LVDS B2+	C75	PEG RX7-	D75	PEG TX7-
A76	LVDS A2-	B76	LVDS B2-	C76	GND	D76	GND
A77	LVDS VDD_EN	B77	LVDS B3+	C77	RSVD	D77	IDE_CBLID#
A78	LVDS A3+	B78	LVDS B3-	C78	PEG RX8+	D78	PEG TX8+
A79	LVDS A3-	B79	LVDS_BKLT_EN	C79	PEG RX8-	D79	PEG TX8-
A80	GND (FIXED)	B80	GND (FIXED)	C80	GND (FIXED)	D80	GND (FIXED)
A81	LVDS A_CK+	B81	LVDS B_CK+	C81	PEG RX9+	D81	PEG TX9+
A82	LVDS A_CK-	B82	LVDS B_CK-	C82	PEG RX9-	D82	PEG TX9-
A83	LVDS I2C_CK	B83	LVDS_BKLT_Ctrl	C83	RSVD	D83	RSVD
A84	LVDS I2C_DAT	B84	VCC_5V_SBY	C84	GND	D84	GND
A85	GPI3	B85	VCC_5V_SBY	C85	PEG RX10+	D85	PEG TX10+
A86	KBD_RSD#	B86	VCC_5V_SBY	C86	PEG RX10-	D86	PEG TX10-
A87	KBD_A20GATE	B87	VCC_5V_SBY	C87	GND	D87	GND
A88	PCIE0_CK_REF+	B88	BIOS_DIS1#	C88	PEG RX11+	D88	PEG TX11+
A89	PCIE0_CK_REF-	B89	VGA_RED	C89	PEG RX11-	D89	PEG TX11-
A90	GND (FIXED)	B90	GND (FIXED)	C90	GND (FIXED)	D90	GND (FIXED)
A91	SPI_POWER	B91	VGA_GRN	C91	PEG RX12+	D91	PEG TX12+
A92	SPI_MISO	B92	VGA_BLU	C92	PEG RX12-	D92	PEG TX12-
A93	GPO0	B93	VGA_HSYNC	C93	GND	D93	GND
A94	SPI_CLK	B94	VGA_VSYNC	C94	PEG RX13+	D94	PEG TX13+
A95	SPI_MOSI	B95	VGA_I2C_CK	C95	PEG RX13-	D95	PEG TX13-
A96	GND	B96	VGA_I2C_DATA	C96	GND	D96	GND
A97	NC	B97	SPI_CS#	C97	RSVD	D97	PEG_ENABLE#
A98	RSVD	B98	RSVD	C98	PEG RX14+	D98	PEG TX14+
A99	RSVD	B99	RSVD	C99	PEG RX14-	D99	PEG TX14-
A100	GND (FIXED)	B100	GND (FIXED)	C100	GND (FIXED)	D100	GND (FIXED)
A101	RSVD	B101	RSVD	C101	PEG RX15+	D101	PEG TX15+
A102	RSVD	B102	RSVD	C102	PEG RX15-	D102	PEG TX15-
A103	RSVD	B103	RSVD	C103	GND	D103	GND
A104	VCC_12V	B104	VCC_12V	C104	VCC_12V	D104	VCC_12V
A105	VCC_12V	B105	VCC_12V	C105	VCC_12V	D105	VCC_12V
A106	VCC_12V	B106	VCC_12V	C106	VCC_12V	D106	VCC_12V
A107	VCC_12V	B107	VCC_12V	C107	VCC_12V	D107	VCC_12V
A108	VCC_12V	B108	VCC_12V	C108	VCC_12V	D108	VCC_12V
A109	VCC_12V	B109	VCC_12V	C109	VCC_12V	D109	VCC_12V
A110	GND (FIXED)	B110	GND (FIXED)	C110	GND (FIXED)	D110	GND (FIXED)

BIOS Setup

This chapter describes the different settings available in the AMI (American Megatrends, Inc.) BIOS that comes with the board. The topics covered in this chapter are as follows:

BIOS Introduction	10
BIOS Setup	10
Main BIOS Setup	11
Advanced Settings	12
PCIPnP Settings	19
Boot Settings	20
Security Settings	22
Advanced Chipset Settings	23
Exit Setup	28
Save Changes and Exit	28
Discard Changes and Exit	28
Discard Changes	28
Load Optimal Defaults	28
Load Failsafe Defaults	28

BIOS Introduction

The BIOS provides critical low-level support for a standard device such as disk drives, serial ports and parallel ports. It also adds virus and password protection as well as special support for detailed fine-tuning of the chipset controlling the entire system.

BIOS Setup

The BIOS provides a Setup utility program for specifying the system configurations and settings. The BIOS ROM of the system stores the Setup utility. When you turn on the computer, the BIOS is immediately activated. Pressing the key immediately allows you to enter the Setup utility. If you are a little bit late pressing the key, POST (Power On Self Test) will continue with its test routines, thus preventing you from invoking the Setup. If you still wish to enter Setup, restart the system by pressing the "Reset" button or simultaneously pressing the <Ctrl>, <Alt> and <Delete> keys. You can also restart by turning the system Off and back On again. The following message will appear on the screen:

Press to Enter Setup

In general, you press the arrow keys to highlight items, <Enter> to select, the <PgUp> and <PgDn> keys to change entries, <F1> for help and <Esc> to quit.

When you enter the Setup utility, the Main Menu screen will appear on the screen. The Main Menu allows you to select from various setup functions and exit choices.

Main BIOS Setup

This setup allows you to record some basic hardware configurations in your computer system and set the system clock.

BIOS SETUP UTILITY						
Main	Advanced	PCIPnP	Boot	Security	Chipset	Exit
System Overview AMIBIOS Version :08.00.15 Build Date:09/15/10 Processor AMD Turion™ II Neo N54L Dual Core Processor Speed : 2200MHz Count : 2 System Memory Size : 1792MB System Time [17:00:00] System Date [Thu 09/13/2010]				Use[ENTER], [TAB] or [SHIFT-TAB] to select a field. Use [+] or [-] to configure system Time. <- Select Screen ↑↓ Select Item +- Change Field Tab Select Field F1 General Help F10 Save and Exit ESC Exit		

Note: *If the system cannot boot after making and saving system changes with Setup, the AMI BIOS supports an override to the CMOS settings that resets your system to its default.*

Warning: *It is strongly recommended that you avoid making any changes to the chipset defaults. These defaults have been carefully chosen by both AMI and your system manufacturer to provide the absolute maximum performance and reliability. Changing the defaults could cause the system to become unstable and crash in some cases.*

Advanced Settings

This section allows you to configure and improve your system and allows you to set up some system features according to your preference.

BIOS SETUP UTILITY

Main	Advanced	PCIPnP	Boot	Security	Chipset	Exit
Advanced Settings					Configure CPU.	
<p>WARNING: Setting wrong values in below sections may cause system to malfunction.</p> <ul style="list-style-type: none"> ▶ CPU Configurations ▶ IDE Configuration ▶ Super IO Configuration ▶ ACPI Configuration ▶ AHCI Configuration ▶ Hardware Health Configuration ▶ PCI Express Configuration ▶ USB Configuration ▶ Lan Configuration ▶ Power Configuration 					<p><- Select Screen ↑↓ Select Item Enter Go to Sub Screen F1 General Help F10 Save and Exit ESC Exit</p>	

The fields in each section are shown in the following sections, as seen in the computer screen. Please note that setting the wrong values may cause the system to malfunction. If unsure, please contact technical support of your supplier.

BIOS SETUP UTILITY

Advanced	
CPU Configuration	
Module Version: 15.08 AGESA Version: 1.0.0.0 Physical Count: 1 Logical Count: 2	This option should remain disabled for the normal operation. The driver developer may enable it for testing purpose.
AMD Turion™ II Neo N54L Dual Core Processor Revision: C3 Cache L1: 256KB Cache L2: 2048KB Cache L3: N/A Speed: 2200MHz, NB Clk: 1600MHz Able to Change Freq. : Yes uCode Patch Level: 0x10000B6	
GART Error Reporting [Disabled] Microcode Update [Enabled] Secure Virtual Machine Mode [Enabled] PowerNow [Enabled] C1E Support [Enable]	<p><- Select Screen ↑↓ Select Item +- Change Field F1 General Help F10 Save and Exit ESC Exit</p>

BIOS SETUP UTILITY

Advanced	
IDE Configuration	
OnBoard PCI IDE Controller	[Both]
▶ Primary IDE Master	: [Not Detected]
▶ Primary IDE Slave	: [Not Detected]
▶ Secondary IDE Master	: [Not Detected]
▶ Secondary IDE Slave	: [Not Detected]
▶ Third IDE Master	: [Not Detected]
▶ Third IDE Slave	: [Not Detected]
▶ Fourth IDE Master	: [Not Detected]
▶ Fourth IDE Slave	: [Not Detected]
Hard Disk Write Protect	[Disabled]
IDE Detect Time Out (Sec)	[35]
ATA(PI) 80Pin Cable Detection	[Host & Device]
DISABLED: disables the integrated IDE Controller. PRIMARY: enables only the Primary IDE Controller. SECONDARY: enables only the Secondary IDE Controller. BOTH: enables both IDE Controllers.	
<- Select Screen ↑↓ Select Item +- Change Field F1 General Help F10 Save and Exit ESC Exit	

The IDE Configuration menu is used to change and/or set the configuration of the IDE devices installed in the system.

BIOS SETUP UTILITY

Advanced	
Configure Win627EHF Super IO Chipset	
Floppy A	[Disabled]
Serial Port1 Address	[3F8/IRQ4]
Serial Port2 Address	[2F8/IRQ3]
Serial Port2 Mode	[Normal]
Parallel Port1 Address	[378]
Parallel Port Mode	[Normal]
Parallel Port IRQ	[IRQ7]
Restore on AC Power Loss	[Power Off]
Power On function	[None]
Allows BIOS to Select Serial Port Base Addresses	
<- Select Screen	
↑↓ Select Item	
+- Change Field	
F1 General Help	
F10 Save and Exit	
ESC Exit	

Onboard Serial Port

The default values are:

- Serial Port 1: 3F8/IRQ4
- Serial Port 2: 2F8/IRQ3

Restore on AC Power Loss

This field sets the system power status whether *Power On or Power Off* when power returns to the system from a power failure situation.

Advanced	
Configure Secondary Fintek F81216D Super IO Chipset	
Serial Port3 Address	[3E8]
Serial Port3 Mode	[5]
Serial Port4 Address	[2E8]
Serial Port4 Mode	[10]
Allows BIOS to Select Serial Port Base Addresses	
<- Select Screen	
↑↓ Select Item	
+- Change Field	
F1 General Help	
F10 Save and Exit	
ESC Exit	

BIOS SETUP UTILITY

Advanced	
ACPI Settings	General ACPI Configuration settings
<ul style="list-style-type: none"> ▶ General ACPI Configuration ▶ Advanced ACPI Configuration 	

BIOS SETUP UTILITY

Advanced				
General ACPI Configuration	Select the ACPI state used for System Suspend.			
<table border="0"> <tr> <td>Suspend mode</td> <td>[S1 (POS)]</td> </tr> <tr> <td>C1E Support</td> <td>[Enable]</td> </tr> </table>		Suspend mode	[S1 (POS)]	C1E Support
Suspend mode	[S1 (POS)]			
C1E Support	[Enable]			

BIOS SETUP UTILITY

Advanced								
Advanced ACPI Configuration	Enable RSDP pointers to 64-bit Fixed System Description Tables. Different ACPI version Has some addition							
<table border="0"> <tr> <td>ACPI Version Features</td> <td>[ACPI v1.0]</td> </tr> <tr> <td>ACPI APIC support</td> <td>[Enabled]</td> </tr> <tr> <td>AMI OEMB table</td> <td>[Enabled]</td> </tr> <tr> <td>Headless mode</td> <td>[Disabled]</td> </tr> </table>		ACPI Version Features	[ACPI v1.0]	ACPI APIC support	[Enabled]	AMI OEMB table	[Enabled]	Headless mode
ACPI Version Features	[ACPI v1.0]							
ACPI APIC support	[Enabled]							
AMI OEMB table	[Enabled]							
Headless mode	[Disabled]							

BIOS SETUP UTILITY

Advanced		
AHCI Settings	[Enabled]	Enables for supporting AHCI controller in AHCI mode during BIOS control otherwise operates in IDE mode.
AHCI BIOS Support		
AHCI Port0	[Not Detected]	
AHCI Port1	[Not Detected]	
AHCI Port2	[Not Detected]	
AHCI Port3	[Not Detected]	
AHCI Port4	[Not Detected]	
AHCI Port5	[Not Detected]	

BIOS SETUP UTILITY

Advanced		
Hardware Health Configuration		Options
System Temperature	:75°C/167°F	Disabled 80°C/176°F 85°C/185°F 90°C/194°F 95°C/203°F <- Select Screen ↑↓ Select Item +- Change Field Tab Select Field F1 General Help F10 Save and Exit ESC Exit
CPU Temperature	:78°C/172°F	
CPU_VDD_RUN	:1.148V	
CPU_VDDRR	:0.902V	
+3.3V	:3.260V	
+5V	:4.933 V	
VCC	:4.914 V	
5VSB	:4.872 V	
CPU Shutdown Temperature	[Disabled]	

BIOS SETUP UTILITY

Advanced		
PCI Express Configuration		Enables/Disables Pci Express Device Relaxed Ordering.
Relaxed Ordering	[Auto]	
Maximum Payload Size	[Auto]	
Extended Tag Field	[Auto]	
No Snoop	[Auto]	
Maximum Read Request Size	[Auto]	
Active State Power Management	[Disabled]	
Extended Synch	[Auto]	

BIOS SETUP UTILITY

Advanced	
USB Configuration	Configure the USB Mass Storage Class Devices.
Module Version - 2.24.5-13.4	
USB Devices Enabled: 1 Keyboard, 1 Mouse, 1 Drive	
Legacy USB Support [Enabled]	<- Select Screen
USB 2.0 Controller Mode [HiSpeed]	↑↓ Select Item
BIOS EHCI Hand-Off [Enabled]	+ - Change Field
Legacy USB1.1 HC Support [Enabled]	F1 General Help
▶ USB Mass Storage Device Configuration	F10 Save and Exit
	ESC Exit

The USB Configuration menu is used to read USB configuration information and configure the USB settings.

Legacy USB Support

Enables support for legacy USB. AUTO option disables legacy support if no USB devices are connected.

USB 2.0 Controller Mode

Configures the USB 2.0 controller in HiSpeed (480Mbps) or FullSpeed (12Mbps). This option is enabled by HiSpeed.

BIOS EHCI Hand-Off

Enabled/Disabled. This is a workaround for Oses without EHCI hand-off support. The EHCI ownership change should be claimed by EHCI driver.

Legacy USB1.1 HC Support

Support USB1.1 HC.

BIOS SETUP UTILITY

Advanced	
Lan Configuration	Options
Onboard LAN Option ROM [Disabled]	Disabled Enabled

BIOS SETUP UTILITY

Advanced	
Power Configuration	Disable/Enable RTC to generate a wake event.
RTC Resume [Disabled]	
Resume By Ring [Disabled]	
Resume By PCI Card [Disabled]	

PCIPnP Settings

This option configures the PCI/PnP settings.

BIOS SETUP UTILITY			
Main	Advanced	PCIPnP	Boot Security Chipset Exit
Advanced PCI/PnP Settings		NO: lets the BIOS Configure all the Devices in the system. YES: lets the operating system configure Plug and Play (PnP) devices not required for boot if your system has a Plug and Play operating system.	
WARNING: Setting wrong values in below sections may cause system to malfunction.			
Clear NVRAM		[No]	
Plug & Play O/S		[No]	
PCI Latency Timer		[64]	
Allocate IRQ to PCI VGA		[Yes]	
Palette Snooping		[Disabled]	
PCI IDE BusMaster		[Enabled]	
OffBoard PCI/ISA IDE Card		[Auto]	
IRQ3		[Available]	
IRQ4		[Available]	
IRQ5		[Reserved]	
IRQ7		[Available]	
IRQ9		[Available]	
IRQ10		[Reserved]	
IRQ11		[Available]	
IRQ14		[Available]	
IRQ15		[Available]	
DMA Channel 0		[Available]	
DMA Channel 1		[Available]	
DMA Channel 3		[Available]	
DMA Channel 5		[Available]	
DMA Channel 6		[Available]	
DMA Channel 7		[Available]	
Reserved Memory Size		[Disabled]	
		<- Select Screen ↑↓ Select Item +- Change Field F1 General Help F10 Save and Exit ESC Exit	

Clear VRAM

Clear VRAM during system boot.

Plug & Play O/S

This lets BIOS configure all devices in the system or lets the OS configure PnP devices not required for boot if your system has a Plug and Play OS.

Allocate IRQ to PCI VGA

This assigns IRQ to PCI VGA card if card requests IRQ or doesn't assign IRQ to PCI VGA card even if card requests an IRQ.

Palette Snooping

When enabled, PCI will allow VGA palette signals to go to the ISA bus.

PCI IDE BusMaster

This function allows the BIOS to use PCI BusMastering for reading or writing to IDE drives.

OffBoard PCI/ISA IDE Card

This option specifies if an offboard PCI IDE controller adapter card is installed in the computer. You must specify the PCI Expansion slot on the motherboard where the offboard PCI IDE controller is installed. This disables the onboard PCI IDE controller. You must also specify the IRQs for this PCI IDE card.

IRQ#

Use the IRQ# address to specify what IRQs can be assigned to a particular peripheral device.

Boot Settings

BIOS SETUP UTILITY						
Main	Advanced	PCIPnP	Boot	Security	Chipset	Exit
Boot Settings			Configure Settings during System Boot.			
▶ Boot Settings Configuration			<- Select Screen ↑↓ Select Item +- Change Field Enter Go to Sub Screen F1 General Help F10 Save and Exit ESC Exit			
▶ Boot Device Priority						
▶ Hard Disk Drives						
▶ CD/DVD Drives						

BIOS SETUP UTILITY

Boot	
Boot Settings Configuration	
Quick Boot	[Enabled]
Quiet Boot	[Disabled]
AddOn ROM Display Mode	[Force BIOS]
Bootup Num-Lock	[On]
PS/2 Mouse Support	[Auto]
Wait for 'F1' If Error	[Enabled]
Hit 'DEL' Message Display	[Enabled]
Interrupt 19 Capture	[Disabled]
<p>Allows BIOS to skip certain tests while booting. This will decrease the time needed to boot the system.</p> <p><- Select Screen ↑↓ Select Item +- Change Field F1 General Help F10 Save and Exit ESC Exit</p>	

Quick Boot

This allows BIOS to skip certain tests while booting. This will decrease the time needed to boot the system.

Quiet Boot

When disabled, this displays normal POST messages. When enabled, this displays OEM Logo instead of POST messages.

AddOn ROM Display Mode

This allows user to force BIOS/Option ROM of add-on cards to be displayed during quiet boot.

Bootup Num-Lock

This select the power-on state for numlock.

PS/2 Mouse Support

This select support for PS/2 mouse.

Wait for 'F1' If Error

When set to Enabled, the system waits for the F1 key to be pressed when error occurs. This allows option ROM to trap interrupt 19.

Hit Message Display

This displays "Press to run Setup" in POST.

Interrupt 19 Capture

This allows option ROMs to trap interrupt 19.

Security Settings

This setting comes with two options set the system password. Supervisor Password sets a password that will be used to protect the system and Setup utility. User Password sets a password that will be used exclusively on the system. To specify a password, highlight the type you want and press <Enter>. The Enter Password: message prompts on the screen. Type the password and press <Enter>. The system confirms your password by asking you to type it again. After setting a password, the screen automatically returns to the main screen.

To disable a password, just press the <Enter> key when you are prompted to enter the password. A message will confirm the password to be disabled. Once the password is disabled, the system will boot and you can enter Setup freely.

BIOS SETUP UTILITY

Main	Advanced	PCIPnP	Boot	Security	Chipset	Exit
				Security Settings	Install or Change the Password.	
				Supervisor Password : Not Installed		
				User Password : Not Installed		
				Change Supervisor Password	<- Select Screen	
				Change User Password	↑↓ Select Item	
					Enter Change	
					F1 General Help	
				Boot Sector Virus Protection [Disabled]	F10 Save and Exit	
					ESC Exit	

Advanced Chipset Settings

This setting configures the north bridge, south bridge and the ME subsystem. **WARNING!** Setting the wrong values may cause the system to malfunction.

BIOS SETUP UTILITY

Main	Advanced	PCIPnP	Boot	Security	Chipset	Exit
Advanced Chipset Settings					Options for NB	
<ul style="list-style-type: none"> ▶ North Bridge Configuration ▶ North Bridge2 Configuration ▶ South Bridge Configuration 					<- Select Screen ↑↓ Select Item Enter Go to Sub Screen F1 General Help F10 Save and Exit ESC Exit	

BIOS SETUP UTILITY

Chipset	
North Bridge Chipset Configuration	
<ul style="list-style-type: none"> ▶Memory Configuration ▶DRAM Timing Configuration 	
Size of Dimm #0: 1 GB Size of Dimm #1: Non-Presence	
Memory CLK : 400 MHz, N/A CAS Latency(Tcl) : 6 CLK , N/A RAS/CAS dELAY(Trcd) : 6 CLK , N/A Row Precahrge Time (Trp) : 6 CLK , N/A Min Active RAS (Tras) : 15 CLK , N/A RAS/RAS Delay (Trrd) : 4 CLK , N/A Row Cycle (Trc) : 20 CLK , N/A Read to Precharge (Trtp) : 4 CLK , N/A Write Recover Time (Twr) : 6 CLK , N/A	<- Select Screen ↑↓ Select Item Enter Go to Sub Screen F1 General Help F10 Save and Exit ESC Exit
HT Link Width Control	[Enable]
GfxNBPstateDis Support	[Enable]
T0Time Override	[Disabled]

Memory Configuration
BIOS SETUP UTILITY

Memory Configuration		Chipset
Channel Interleaving	[Auto]	Enable Channel Memory Interleaving <- Select Screen ↑↓ Select Item Enter Go to Sub Screen F1 General Help F10 Save and Exit ESC Exit
Enable Clock to All DIMMs	[Disabled]	
Memory Hole Remapping	[Enabled]	
CS Sparing Enable	[Disabled]	
Power Down Enable	[Auto]	
Power Down Mode	[Auto]	
DRAM Parity Enable	[Auto]	
Bank Swizzle Mode	[Auto]	

DRAM Timing Configuration
BIOS SETUP UTILITY

DRAM Timing Configuration		Chipset
DRAM Timing Config	[Auto]	Opts Auto Manual <- Select Screen ↑↓ Select Item Enter Go to Sub Screen F1 General Help F10 Save and Exit ESC Exit

NorthBridge2 Chipset Configuration
BIOS SETUP UTILITY

Chipset	
NorthBridge2 Chipset Configuration	
RS880 CIMx Version : 1.3.0.5	
▶ Internal Graphics Configuration	
NB Power Management Features [Auto]	<- Select Screen ↑↓ Select Item Enter Go to Sub Screen F1 General Help F10 Save and Exit ESC Exit
Memory Hole [Disabled]	

Internal Graphics Configuration
BIOS SETUP UTILITY

Chipset	
Internal Graphics Configuration	Options
Internal Graphics Mode [UMA+SIDEPORT]	Disable
UMA Frame Buffer Size [Auto]	UMA
SIDEPORT Clock Speed [400MHz]	SIDEPORT
GFX Engine Clock Override [Disable]	UMA+SIDEPORT
UMA-SP Interleave Mode [Auto]	
SP Power Management [Auto]	<- Select Screen ↑↓ Select Item Enter Go to Sub Screen F1 General Help F10 Save and Exit ESC Exit
SP NB Termination [Disable]	
SP Memory Termination [Disable]	
SP CMD Hold [Auto]	
SP CMD Hold [Auto]	
Special Graphics Features [Disable]	
FB Location [Below 4G]	
PANEL ID Selection [1024 x 768 24 bit]	

South Bridge Configuration
BIOS SETUP UTILITY

SouthBridge Chipset Configuration		Chipset
<ul style="list-style-type: none"> ▶ SP GPP Port Graphics Configuration ▶ SB Azalia Audio Configuration ▶ SB SATA Configuration 	Options for SB GPP Por	<- Select Screen ↑↓ Select Item Enter Go to Sub Screen F1 General Help F10 Save and Exit ESC Exit

BIOS SETUP UTILITY

SB GPP Port Configuration		Chipset
SB GPP Function [Enable] GPP Port Link Configuration [1:1:1 mode] Unhide unused GPP ports [Disable] GPP Link ASPM [Disable] GPP Lane Reversal [Disabled] NB-SB PHY PLL Power Down [Enable] GPP PHY PLL Power Down [Enable]	Options	Disable Enable <- Select Screen ↑↓ Select Item Enter Go to Sub Screen F1 General Help F10 Save and Exit ESC Exit

BIOS SETUP UTILITY

Onchip HD Azalia Configuration		Chipset
HD Audio Azalia Device [Enabled] HD Onboard PIN Config [Enabled] Azalia Front Panel [Auto] SDIN0 Pin Config [Azalia] SDIN1 Pin Config [Azalia] SDIN2 Pin Config [Azalia] SDIN3 Pin Config [GPIO] Azalia Snoop [Disabled]	Options	Auto Disable Enable <- Select Screen ↑↓ Select Item Enter Go to Sub Screen F1 General Help F10 Save and Exit ESC Exit

BIOS SETUP UTILITY

Onchip SATA Configuration		Chipset
OnChip SATA Channel	[Enabled]	Options
OnChip SATA Type	[IDE]	Auto
OnChip IDE Type	[Legacy IDE]	Disable
SATA IDE Combined Mode	[Enabled]	Enable
PATA Channel Config	[SATA as primary]	
		<- Select Screen
		↑↓ Select Item
		Enter Go to Sub Screen
		F1 General Help
		F10 Save and Exit
		ESC Exit

OnChip SATA Type

The options are:

- (1) IDE
- (2) RAID
- (3) AHCI

Exit Setup

The exit setup has the following settings which are:

BIOS SETUP UTILITY						
Main	Advanced	PCIPnP	Boot	Security	Chipset	Exit
Exit Options					Exit system setup after saving the changes.	
Save Changes and Exit					F10 key can be used for this operation	
Discard Changes and Exit						
Discard Changes						
Load Optimal Defaults						
Load Failsafe Defaults						
					<- Select Screen ↑↓ Select Item Enter Go to Sub Screen F1 General Help F10 Save and Exit ESC Exit	

Save Changes and Exit

This option allows you to determine whether or not to accept the modifications and save all changes into the CMOS memory before exit.

Discard Changes and Exit

This option allows you to exit the Setup utility without saving the changes you have made in this session.

Discard Changes

This option allows you to discard all the changes that you have made in this session.

Load Optimal Defaults

This option allows you to load the default values to your system configuration. These default settings are optimal and enable all high performance features.

Load Failsafe Defaults

This option allows you to load the troubleshooting default values permanently stored in the BIOS ROM. These default settings are non-optimal and disable all high-performance features.

Drivers Installation

This section describes the installation procedures for software and drivers under the Windows XP and Windows Vista. The software and drivers are included with the board. If you find the items missing, please contact the vendor where you made the purchase. The contents of this section include the following:

VGA Drivers Installation	30
Audio Drivers Installation	35
LAN Drivers Installation	36
Marvell LAN Drivers Installation (IP401-B1 carrier board only).....	38

VGA Drivers Installation

1. Insert the CD that comes with the board. Click **AMD** then **AMD 785E Chipset Drivers** and then **AMD 785E Series Graphics Drivers**.

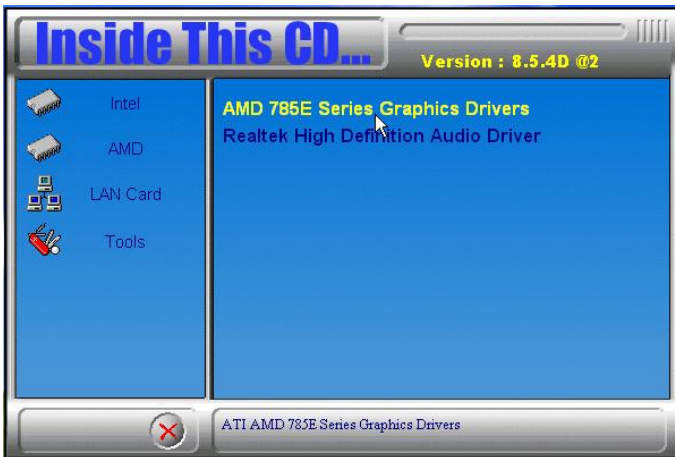

2. When the Welcome Screen appears, click *Next*. Click *Install* to install the ATI software components.

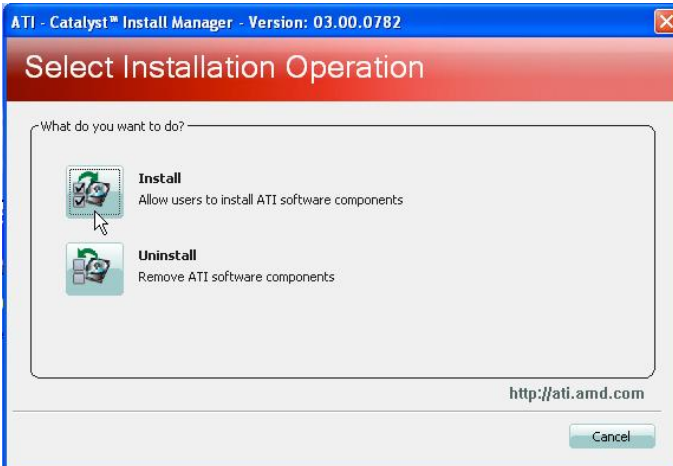
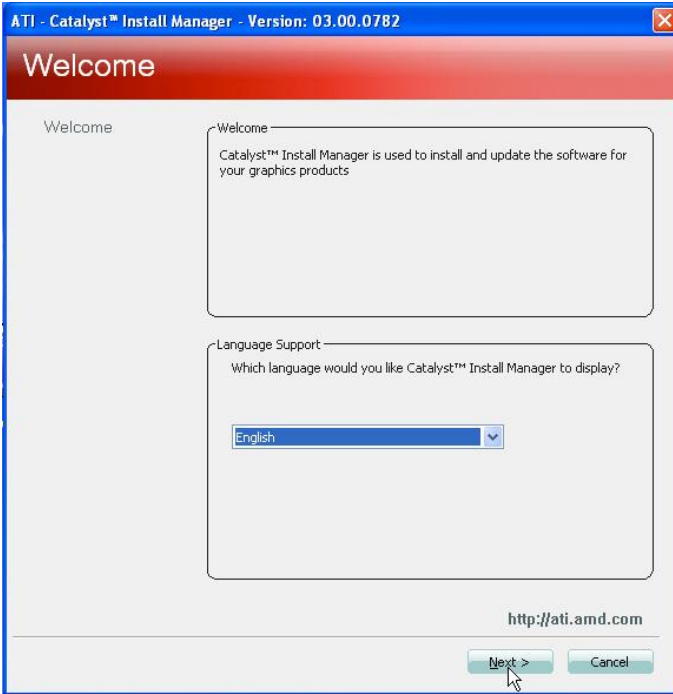

3. Click **Custom** and select the components to install as shown.

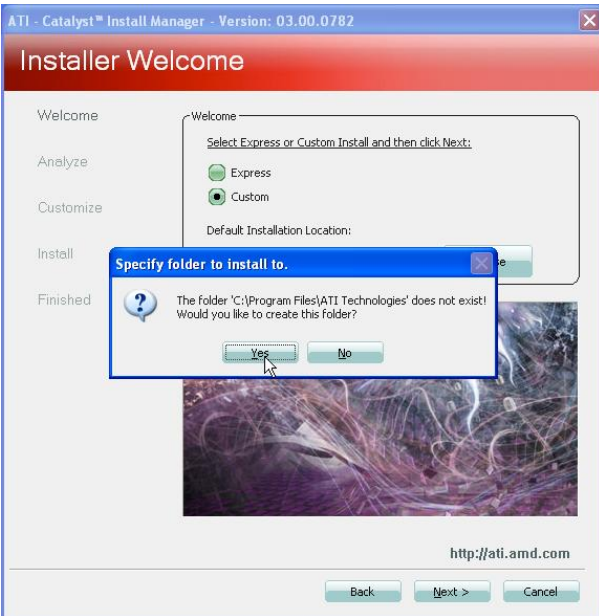

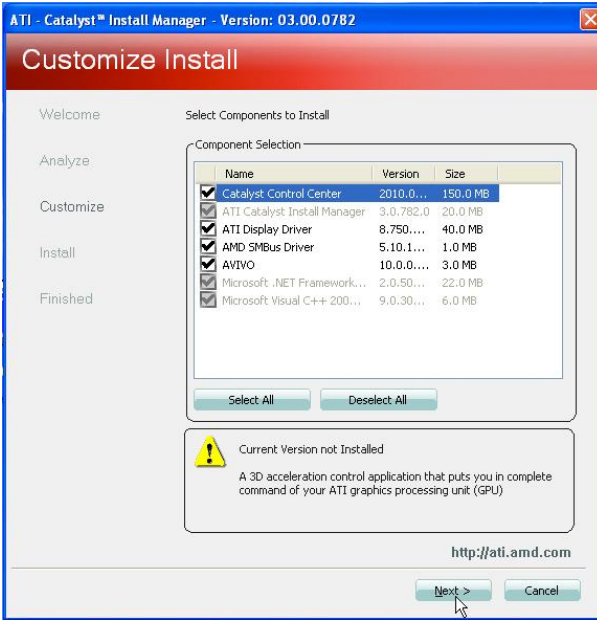

4. Accept the license agreement to proceed with installation. Reboot the computer when prompted for changes to take effect.



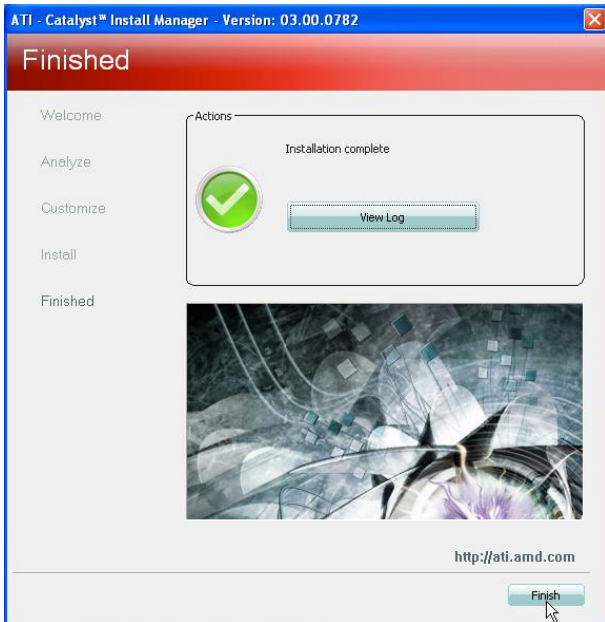

Audio Drivers Installation

1. Insert the CD that comes with the board. Click **AMD** then **AMD 785E Chipset Drivers** and then **Realtek High Definition Audio Driver**.

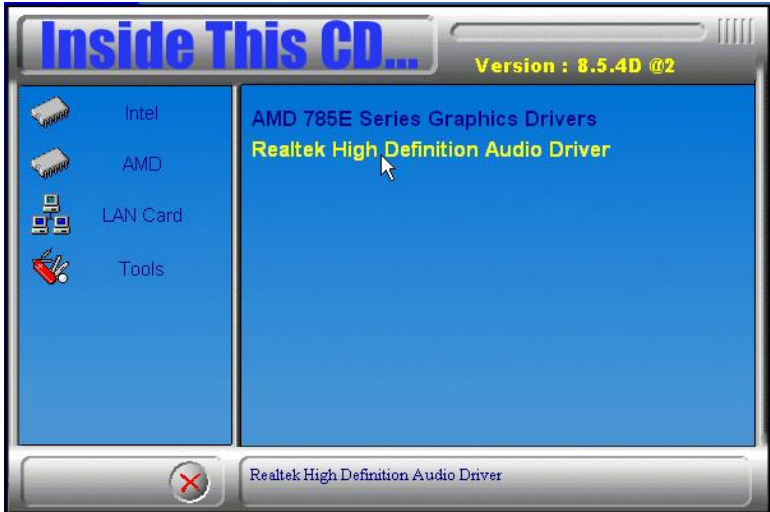

2. The Welcome screen to the InstallShield Wizard for Realtek High Definition Audio Driver will appear. At this point, click **Next** to continue the installation process.

3. When installation is completed, restart the computer as prompted. Click **Finish**.

LAN Drivers Installation

1. Insert the CD that comes with the board. Click **LAN Card** at the left side and then **Realtek LAN Controller Drivers**.



2. In the welcome screen of the InstallShield Wizard for REALTEK GbE & FE Ethernet PCI-E NIC Driver, click *Next*.

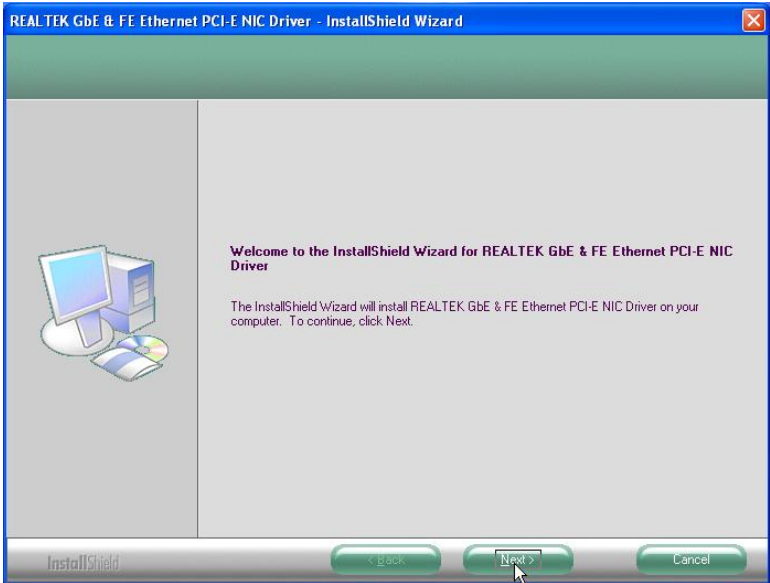

3. In the InstallShield Wizard screen, click *Install* to begin the installation.

4. InstallShield Wizard completed. Click *Finish* to exit the Wizard.

Marvell LAN Drivers Installation (IP401-B1 carrier board only)

Follow the steps below to complete the installation of the Intel PRO LAN drivers.

1. Insert the CD that comes with the board. Click **LAN Card** and then **Marvell LAN Controller Driver**.



2. When the Welcome screen appears, click **Next** to continue.



3. Click **Next** to agree with the license agreement.
4. When the Readme Information appears, click **Next** to continue
5. When the Ready to Install the Program appears, click **Install** to continue.
6. After the installation is complete, click **Finish**.

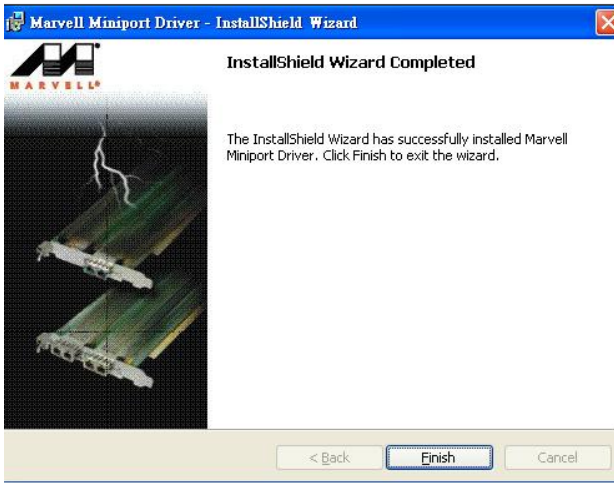

7. To use the wake up function with PCIe LAN, go to the **Device Manager under Windows** and select **LAN controller**. The window for **Generic Marvell Yukon Chipset based Ethernet Controller Properties** will appear. Click **Advanced** and select **Wake From Shutdown**. In the Value field on the right, select **On**.
8. Then, also in the **Advanced** section, click on **Wake Up Capabilities**. In the Value field on the right, select **Magic Packet**, then click **OK**.

This page is intentionally left blank.